



# SLING PSYCHROMETER

Configuration • Operation • Maintenance

Part Number: 0012-9015

November 2017, Rev. 7

## For Use with Spirit Thermometers

P/N 0012-7012 (30° to 110° F, Red Spirit)

P/N 0012-7043 (-5° to 50° C, Blue Spirit)

## Discontinued Mercury Thermometers

P/N 0012-7011 (30° to 110° F, Mercury)

P/N 0012-7013 (-5° to 50° C, Mercury)



**CAUTION:** *Damage to thermometers or plastic case will result if instrument is exposed to direct sunlight or excessive heat for prolonged periods.*

### WARRANTY

Bacharach, Inc. warrants to Buyer that at the time of delivery this Product will be free from defects in material and manufacture and will conform substantially to Bacharach Inc.'s applicable specifications. Bacharach's liability and Buyer's remedy under this warranty are limited to the repair or replacement, at Bacharach's option, of this Product or parts thereof returned to Seller at the factory of manufacture and shown to Bacharach Inc.'s reasonable satisfaction to have been defective; provided that written notice of the defect shall have been given by Buyer to Bacharach Inc. within one (1) year after the date of delivery of this Product by Bacharach, Inc. For full details concerning this warranty, contact Bacharach Inc.

Product Leadership • Training • Service • Reliability

# Sling Psychrometer

## Overview

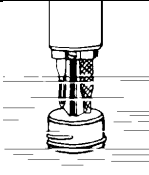
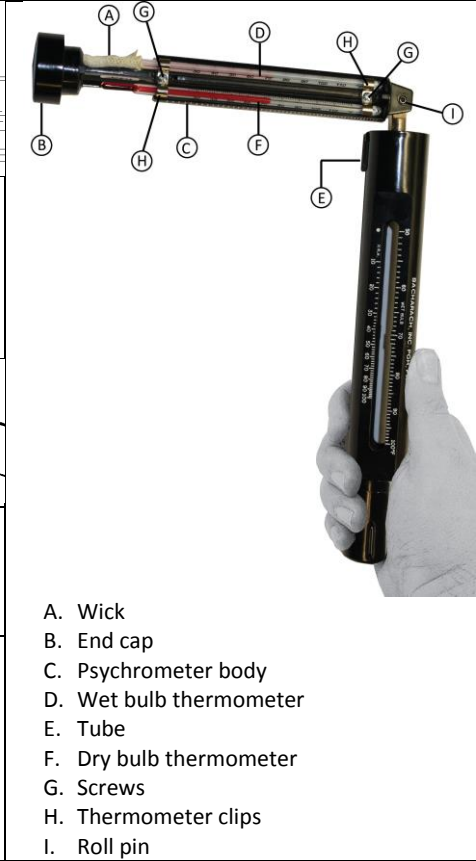
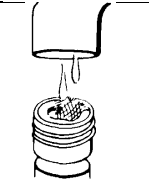
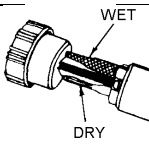
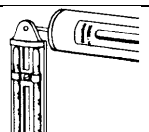
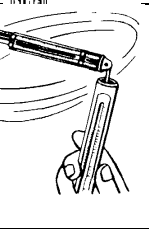
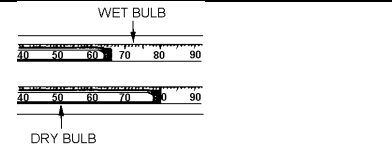
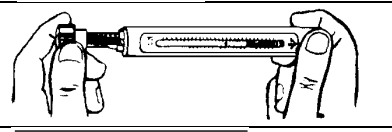
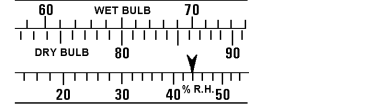
<p>1. Remove cap (B) then immerse end of body to saturate wick (A).</p>		 <ul style="list-style-type: none"> <li>A. Wick</li> <li>B. End cap</li> <li>C. Psychrometer body</li> <li>D. Wet bulb thermometer</li> <li>E. Tube</li> <li>F. Dry bulb thermometer</li> <li>G. Screws</li> <li>H. Thermometer clips</li> <li>I. Roll pin</li> </ul>
<p>2. Fill psychrometer reservoir with water. Replace cap (B).</p>		
<p>3. Be sure wick covers "wet" bulb. The other bulb is dry.</p>		
<p>4. Pull body (C) from tube (E) until body hangs free.</p>		
<p>5. Use tube (E) as handle; whirl body (C) about 1-½ minutes.</p>		
<p>6. Read wet and dry bulb thermometers; replace body in tube.</p>		
<p>7. Set thermometer readings on upper two calculator scales.</p>		
<p>8. Read % relative humidity as indicated by arrow.</p>		

## **Operation**

1. To ensure WICK (A) is saturated with water and covers spirit reservoir on WET BULB THERMOMETER (D), remove END CAP (B) and immerse PSYCHROMETER BODY (C) up to the thermometer reservoirs until WICK is thoroughly wetted.
2. Fill END CAP with water and replace; tighten just enough to prevent leakage. Be sure reservoir on other THERMOMETER (F) is dry.
3. Pull TUBE (E) clear of BODY so BODY can swivel.
4. Holding TUBE, whirl body two to three revolutions per second (120 to 180 RPM).
5. Continue whirling until temperatures stabilize (1-½ minutes is usually ample).
6. Immediately read WET BULB THERMOMETER (D) and then DRY BULB THERMOMETER (F). (See application instructions.)
7. Set wet and dry bulb temperatures opposite each other on side rule type calculator scales, sliding BODY into TUBE as required.
8. Read % R.H. (percent relative humidity) indicated by arrowhead on lower scale.

## **Application**

Wet-bulb temperatures should be read first and as quickly as possible for highest accuracy. Delay in reading may cause error. In addition, the wick must be kept clean, saturated with water, and whirled long enough to stabilize temperatures.

The range of the psychrometer is from 10% to 100% R.H., for dry-bulb temperatures of 30° to 100°F (-5° to 50°C).

In addition to the above instructions, barometric pressure and other factors will influence exact relative humidity determinations to a very minor degree. For precise work, use a psychrometric chart or set of tables such as W.B. No. 235 "Psychrometric Tables for Obtaining the Vapor Pressure, Relative Humidity, and Temperature of Dew Point," which can be purchased from the Superintendent of Documents, United States Government Printing Office, Washington, D.C. The accuracy of the Psychrometer, however, is satisfactory for all except the most exacting work.

## **Maintenance**

WICK (A) should be kept clean. When dirty, cut off WICK below WET BULB THERMOMETER (D) and pull clean section out of END CAP (B) and slide over bulb on WET BULB THERMOMETER.

A WICK REPLACEMENT KIT may be purchased separately (refer to parts list). One or two extra WICKS may be kept in END CAP and will help retain moisture longer. Pack WICKS loosely to allow thorough water saturation and ample water supply to the WET BULB THERMOMETER.

THERMOMETERS (D) and (F) are replaceable by backing off SCREWS (G) and loosening THERMOMETER CLIPS (H). To separate BODY (C) and TUBE (E), drive ROLL PIN (I) out of eye in PLUG AND SWIVEL ASSEMBLY, which then may be slid out back end of TUBE.

# Sling Psychrometer

## Parts and Accessories

Part Number	Description	Qty per Assembly 0012-xxxx			
		7011	7012	7013	7043
0012-0180	Plug and Swivel Assembly	1	1	1	1
0012-0176	Thermometer Clip	2	2	2	2
0012-0007	Wick	1	1	1	1
0002-1740	Screw	2	2	2	2
0002-6858	Roll Pin	1	1	1	1
0006-5456	Cap	1	1	1	1
0012-0012	Friction Ring	2	2	2	2
0012-0194	Body (°F)	1	1	-	-
0012-0018	Body (°C)	-	-	1	1
0012-0006	Tube (°F)	1	1	-	-
0012-0019	Tube (°C)	-	-	1	1
0012-0266	Thermometer, 30 to 110°F, Red Spirit	2	2	-	-
0012-0327	Thermometer, -5 to 50°C, Blue Spirit	-	-	2	2

Part Number	Description	Qty
0012-0011	Wick Replacement Kit containing	4 Wicks

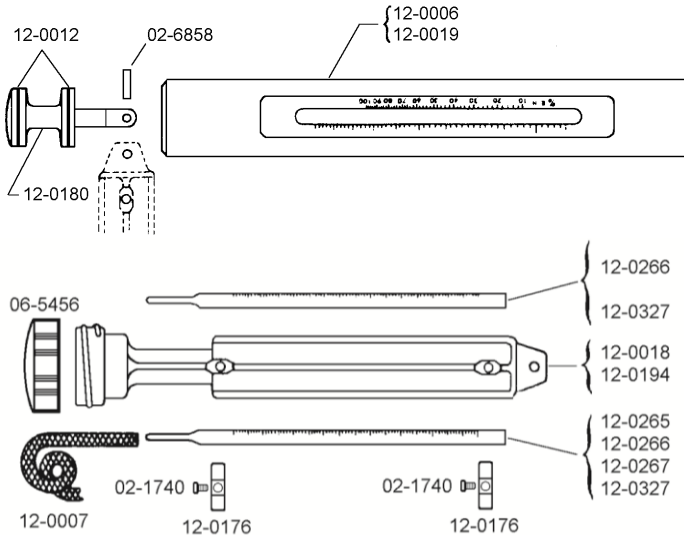

### Bacharach, Inc.

621 Hunt Valley Circle

New Kensington, PA 15068 USA

Pittsburgh, PA USA | Dublin, IRE | Gloucester, UK | Stanardsville, VA USA | Toronto, CAN  
[mybacharach.com](http://mybacharach.com) | [help@mybacharach.com](mailto:help@mybacharach.com)